

Article number: 20343650M12100OS

Description: E+G levelling foot
GN 343.6-50-M12-100-OS

Measures

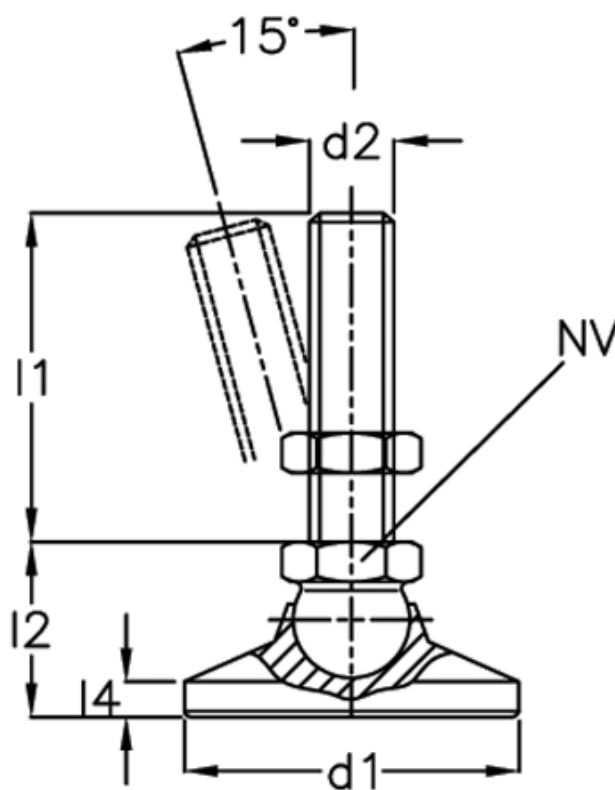

A/F	= 17
d1	= 50
d2	= 12
l1	= 100
l2	= 36
l4	= -
Static load (N)	= 16
Weight in (g)	= 275